

COMMISSIONING & STARTUP GUIDE

1	INTRODUCTION	1
2	SYSTEM DESCRIPTION	3
3	INSTALLATION	5
3.1	INPUT/OUTPUT POSITIONING	5
3.2	CONTROLLER WIRING	6
3.2.1	Dual Fuel	6
	Single Fuel	7
3.3	BUILT-IN ANALOG INPUTS	8
4	GENERAL OPERATIONS	9
4.1	VIEWING AND ACKNOWLEDGING ALARMS	9
4.2	OPERATING THE LOOP DISPLAY	10
4.2.1	Boiler Master – Bias Station Display	10
4.2.2	Boiler Master - Drum Pressure Display	11
4.2.3	Oxygen Display	12
4.2.4	Control Keys	13
4.2.5	Operating the Auto/Manual Key	13
4.2.6	R/L Key	13
4.2.7	Operating the Scroll key	14
4.2.8	Operating the Ramp keys	15
4.3	TUNING	16
4.3.1	Tuning Password	16
4.3.2	Changing Tuning Parameters	17
5	CONTROLLER INITIALIZATION	18
5.1	ACKNOWLEDGE AND CORRECT DIAGNOSTIC ALARMS	18
5.2	VIEW AND ACKNOWLEDGE PROCESS ALARMS	19
5.2.1	Drum Pressure Loop Alarms	19
5.2.2	O ₂ Loop Alarms	20
5.2.3	Quality Alarms	21
5.3	VIEW AND VERIFY ACTUAL I/O VALUES	23
6	BOILER MASTER SETUP	26
7	OXYGEN LOOP SETUP	31
8	VERIFY FINAL CONTROL ELEMENT OPERATION	34
9	COMBUSTION TEST	39
9.1	PREPARING THE CONTROLLER FOR THE COMBUSTION TEST	39
9.2	PERFORMING THE COMBUSTION TEST	40
9.2.1	Reading and recording the Low Fire settings	40
9.2.2	Setting and recording combustion data	42
10	COMBUSTION PARAMETER ENTRY	44
10.1	O ₂ SETPOINT TABLES	44
10.2	FUEL/AIR RATIO TABLES	48
11	CONTROL LOOP TUNING	54
11.1	DRUM PRESSURE	54
	APPENDIX A SYSTEM DIAGRAMS	61

COMMISSIONING & STARTUP GUIDE

APPENDIX B ORDER OF TUNING DISPLAYS 64

APPENDIX C COMBUSTION TEST FORMS 72

APPENDIX D BOILER CONTROL SYSTEM GENERAL START-UP PROCEDURES 74

APPENDIX E COMMUNICATION TO HOST PC..... 76

1 INTRODUCTION

This guide provides instructions for startup and tuning of the TrimPAK Combustion Controller.

The available displays in the controller are listed below:

Operating displays

- Boiler Master (Drum Pressure or Bias Station)
- Oxygen (O₂ Trim loop)
- Boiler Efficiency (with efficiency calculation option only)

Tuning displays

- Boiler Master
 - Mode Select (Bias Station, Drum Pressure or Dual)
 - Oil Gain
 - Oil Reset
 - Gas Gain
 - Gas Reset
 - Drum pressure engineering units – low
 - Drum pressure engineering units – high
 - Drum pressure filter time
 - Low alarm limit
 - High alarm limit
 - Auto Recycle Enable
 - Auto Recycle %
 - Database configuration time/date stamp

- Oxygen
 - Manual control profile
 - Gain
 - Reset
 - O₂ engineering units – low (%)
 - O₂ engineering units – high (%)
 - Low alarm limit
 - Low-low alarm limit
 - Air Position or Fan Speed feedback– low
 - Air Position or Fan Speed feedback– high
 - Trim multiplier – low
 - Trim multiplier – high
 - Air output/position feedback allowed deviation (%)
 - Oil/O₂ setpoint entries X1, Y1...X9, Y9
 - Gas/O₂ setpoint entries X1, Y1...X9, Y9
 - Oil/Air output entries X1, Y1...X9, Y9
 - Gas/Air output entries X1, Y1...X9, Y9

[Back to Index](#)

2 SYSTEM DESCRIPTION

The TrimPAK Combustion Control System consists of parallel positioning control with continuous oxygen trim for a single- or dual-fuel jackshaft boiler. The TrimPAK unit contains the Boiler Master and the Excess Oxygen (O₂) controller. The Boiler Master can be set up to act as a Bias station receiving a signal from a plant master controller, as a Drum Pressure controller receiving a signal from a pressure transmitter, or a Dual Mode controller which allows switching between a bias station and a drum pressure controller when necessary. If the Efficiency Calculation option is installed, there is a display for current boiler efficiency.

The basic system is shown below:

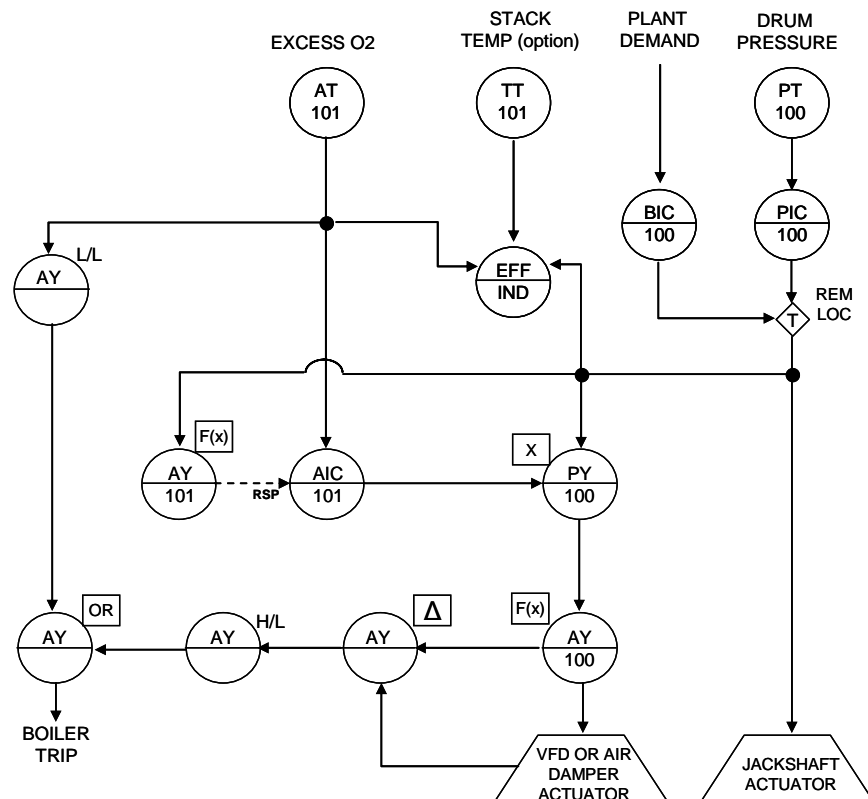

When set up as a Drum Pressure controller, the Boiler Master receives an input signal from the steam pressure transmitter, compares it to a local setpoint, and generates an output signal for air and fuel demand.

When set up as a Bias Station, the Boiler Master receives an input signal from the Plant Master, applies a locally entered bias and generates an output for fuel and air demand.

In either mode, when the Boiler Master is in Manual the control algorithm tracks the manual output to provide bumpless transfer to Automatic.

If the controller is set up for Dual Mode and is being used as a Bias Station, the Drum Pressure controller tracks the output of the Bias station. When it is being used as a Drum Pressure controller, the Bias station tracks the output of the drum pressure controller. This provides bumpless transfer in the event the operator must change the function of the controller.

3 INSTALLATION

This section contains a diagram of the I/O module positioning on the TrimPAK controller, and the wiring diagram for the rear termination block. For more details on the physical and electrical installation of the controller, see **IB-1800R-INS, Installation**.

⚠ **CAUTION** – the wiring recommendations detailed in Section 3 of the Installation Guide IB-1800R-INS must be strictly observed, with particular attention to power and grounding connections, to prevent errors and subsequent damage from electrical noise and discharges.

3.1 Input/Output Positioning

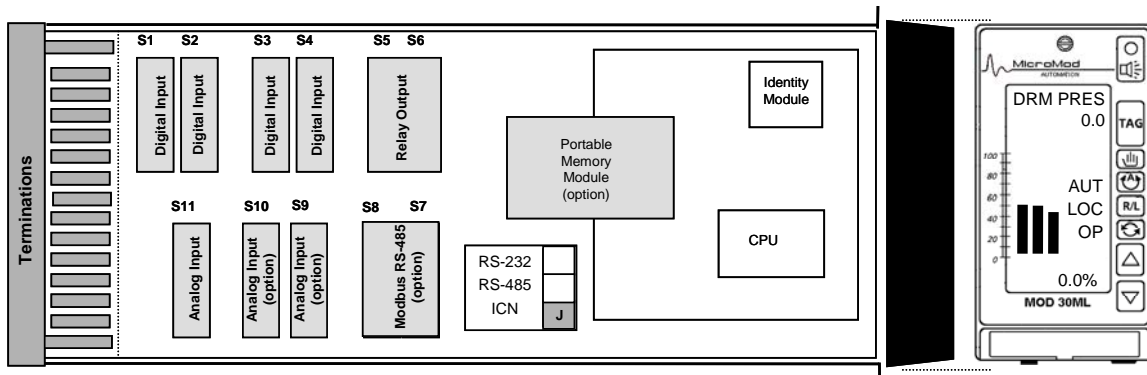

Position	Signal Type	Variable	Source/Destination
Built-In Analog Input #1	4-20 mA	Drum Pressure	Drum pressure transmitter
Built-In Analog Input #2	4-20 mA	Air Feedback	Variable Speed Drive or Actuator Positioner
Built-In Analog Output #1	4-20 mA	Fuel Demand	Jackshaft actuator
Built-In Analog Output #2	4-20 mA	Air Demand	Air Actuator or Variable Speed Drive
Built-In Communication Port	ICN	Peer-to-peer communication	Other SteamPAK controllers (if present)
POSITION 1	Digital Input 110V 2004AP10140A	Auto	BMS
POSITION 2	Digital Input 110V 2004AP10140A	Purge	BMS
POSITION 3	Digital Input 110V 2004AP10140A	Low Fire	BMS
POSITION 4	Digital Input 110V 2004AP10140A	Oil / Gas Selector Switch	BMS
POSITION 5 -6	Relay Output 2011AZ10100A	1) O2 Trip Interlock 2) Alarm	1) BMS 2) Annunciator
POSITION 7 – 8	Modbus RS-485 2034NZ10000B		Communication to PC (option)
POSITION 9	1 – 5 Vdc 2001AZ10101B	Plant Demand	Plant Master controller (if present)
POSITION 10	4-20mA 2002AZ10101B	Stack Temperature	Temperature transmitter (option)
POSITION 11	Input 4-20 mA 2002AZ10101B	Excess Oxygen	O2 analyzer

NOTE: If plant master output is 4-20mA a 250Ω resistor must be installed. If Plant Master Controller is not present the input signal in Slot 10 is ignored.

COMMISSIONING & STARTUP GUIDE

3.2 Controller Wiring

TrimPAK supports single-or dual-fuel boilers. Wiring diagrams for both, including optional inputs and PC communication, are shown below.

3.2.1 Dual Fuel

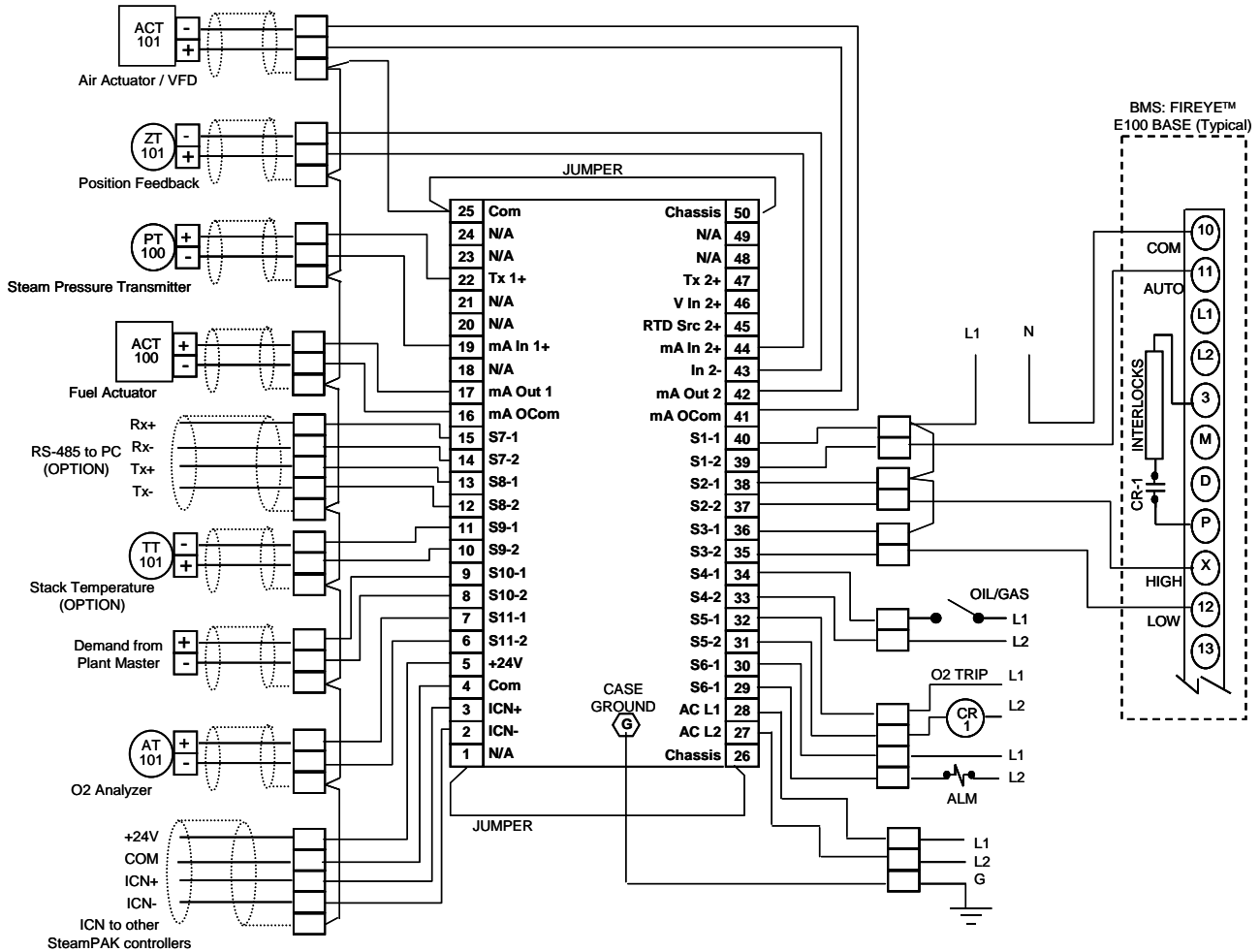

- Field Equipment – 24VDC
- Power feed, annunciator and FIREYE™ – 110VAC
- If Plant Master signal is 4-20mA install a 250 Ω resistor on the input for Slot 10
- Built-in analog inputs and all analog modules must be grounded somewhere in the loop. Test negative wire to field instrument with voltmeter to determine if device is grounded in the field. If not, ground negative signal to instrument common.
- One ICN terminator 2030FZ is required for each ICN network. This should be installed on only one controller, at the end of the ICN network, as shown below:

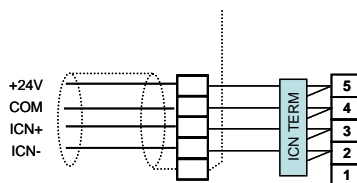

COMMISSIONING & STARTUP GUIDE

4.2 Operating the Loop Display

The loop operating display includes three 8-character alphanumeric lines, three alphanumeric status indicators, and three 50-segment bargraphs. The indicators are referred to in this document by line number (Line 1, Line 2 etc.)

The operational displays for each loop in the TrimPAK system are explained below. The factory default values for Drum Pressure and Oxygen ranges are set to correspond to the ranges of the standard SteamPAK pressure transmitter and the oxygen analyzer.

4.2.1 Boiler Master – Bias Station Display

This display appears only when the Boiler Master is set up as a Bias Station or Dual Mode controller. If there is no Drum Pressure signal or the setpoint is Remote, the Boiler Master functions as a Bias station.

Left Bar indicates the demand in percent

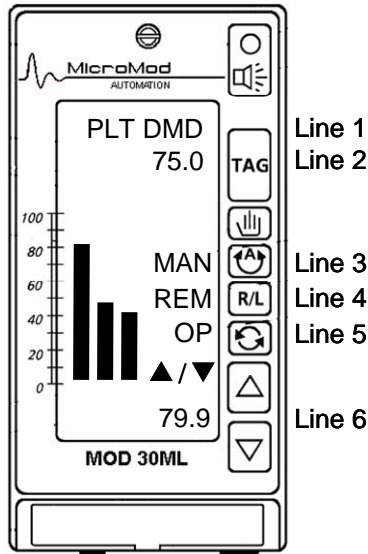

Middle Bar indicates the Bias

-100 to +100%

Right Bar indicates the output to the fuel actuator

Plant Demand + Bias

Line 1 indicates the tag

PLT DMD

Line 2 indicates the Plant Demand in per cent

-100 to +100%

Line 3 indicates the control mode

MAN (manual)

AUT (automatic)

TRK (track) – Low Fire or Purge signal from BMS is present

Line 4 indicates the setpoint mode

REM (Remote – from plant master)

Line 5 indicates which variable is displayed on line 6

OP (output) or BI (bias)

Up/Down arrows indicate that the value on line 6 can be manually altered

▲/▼

Line 6 indicates the value of the variable on line 5

Output or Bias

4.2.2 Boiler Master - Drum Pressure Display

Left Bar indicates the drum pressure in engineering units

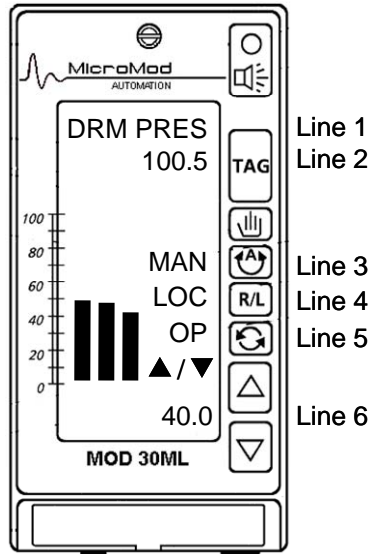

Middle Bar indicates the drum pressure (fuel) setpoint

Right Bar indicates the output to the fuel actuator

Line 1 indicates the loop tag

Line 2 indicates the drum pressure in psig

Line 3 indicates the control mode

Line 4 indicates the setpoint mode

Line 5 indicates which variable is displayed on line 6

Up/Down arrows indicate that the value on line 6 can be manually altered

Line 6 indicates the value of the variable on line 5

DRM PRES

100

MAN (manual)

AUT (automatic)

TRK (track) – Low Fire or Purge signal from BMS is present

LOC (local)

OP (output) or SP (setpoint)

▲/▼

40.0 %

COMMISSIONING & STARTUP GUIDE

4.2.3 Oxygen Display

Left Bar indicates the Excess O2 in percent

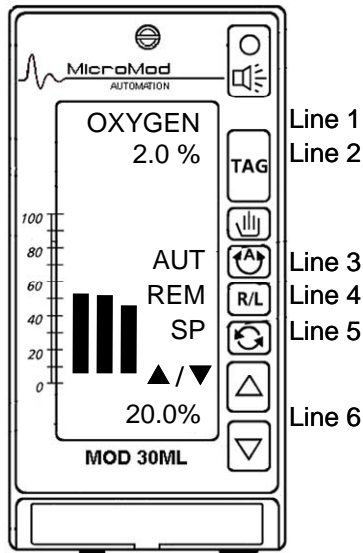

 Note: In normal operation, the output indication represents the O2 trim, NOT the output to the VFD or air actuator

Middle Bar indicates the excess O2 setpoint

Right Bar indicates the % TRIM

Line 1 indicates the loop tag

Line 2 indicates the excess O2 in percent

Line 3 indicates the control mode (auto/manual)

Line 4 indicates the setpoint mode (remote only)

Line 5 indicates which variable is displayed on line 6

Up/Down arrows indicate that the value on line 6 can be manually altered

Line 6 indicates the value of the variable on line 5

This value is the result of the combustion (piecewise) tables and cannot be adjusted by the operator.

The output of this loop functions as a trim to the output from the Boiler Master to the VFD or actuator

OXYGEN

2.0 %

MAN (manual)

AUT (automatic)

TRK (track) – Low Fire or Purge signal from BMS is present

REM (remote)

OP (output) or SP (setpoint)

▲/▼

40.0 %

[Back to Index](#)

5.2 View and acknowledge process alarms

Standard process alarms are configured for Drum Pressure and Excess O2.

5.2.1 Drum Pressure Loop Alarms

Low Drum Pressure

Generates an alarm when drum pressure falls below the configured low alarm limit.

The factory default value is 100 (psig); this value may have been changed during commissioning and startup.

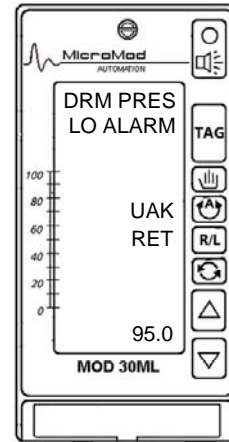

High Drum Pressure

Generates an alarm when drum pressure rises above the configured alarm point.

The factory default value is 230 (psig); this value may have been changed during commissioning and startup.

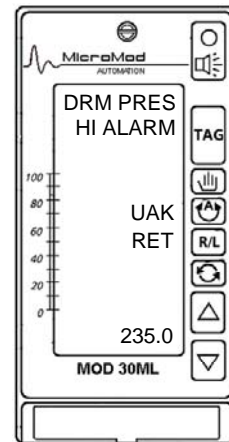

COMMISSIONING & STARTUP GUIDE

5.2.2 O2 Loop Alarms

Low Excess Oxygen

Generates an alarm when excess air falls below the configured low alarm limit.

The factory default value is 2%; this value may have been changed during commissioning and startup.

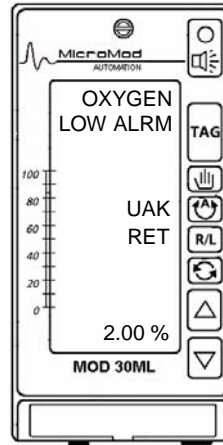

Low-low Excess Oxygen

Generates an alarm when excess air falls below the configured low-low alarm limit.

The factory default value is 1%; this value may have been changed during commissioning and startup.

This alarm will cause the boiler to trip.

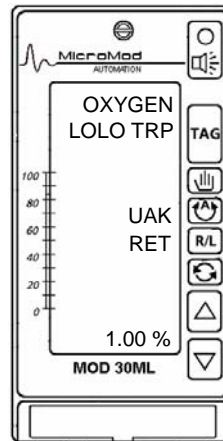

Air Feedback Deviation

Generates an alarm when the deviation between the O2 Controller output and the fan speed or actuator position feedback signal is greater than the configured value.

The factory default value is 2%; this value may have been changed during commissioning and startup.

The Air Feedback signal must be present for TrimPAK to allow the boiler to start.

⚠ WARNING: FOR SAFETY MAXIMUM ALLOWED DEVIATION IS 10%.

This alarm will cause the boiler to trip.

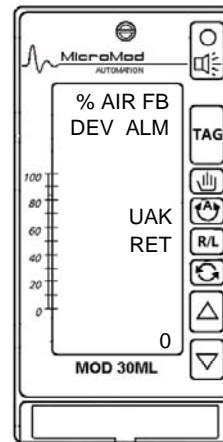

[Back to Index](#)

COMMISSIONING & STARTUP GUIDE

9.2 Performing the combustion test

With a Variable Speed Drive the combustion test involves setting the VFD at 70% and raising the Drum Pressure output in 10% increments until the air damper is approximately 80-90% open, adjusting the mechanical cams at each step, then raising the output to the VFD as well as raising the Drum Pressure output until the boiler reaches full load.

With an Air Actuator, the combustion test involves setting the air actuator and Drum Pressure output at approximately 10% (low fire position) and adjusting the air to obtain the correct oxygen reading (typically 6 to 8% at low fire). Then raise the air and pressure output in 10% increments, adjusting for correct oxygen, until full load is reached.

△ Always increase air before fuel (pressure output)

9.2.1 Reading and recording the Low Fire settings



Press the TAG key to switch to the OXYGEN display

- Line 1 reads OXYGEN
- Line 2 shows the O2 in percent
- Line 3 shows - - - , indicating direct control of the air actuator or VFD
- Line 4 shows actual deviation between air output and position or speed feedback
- Line 5 should read OP (output)

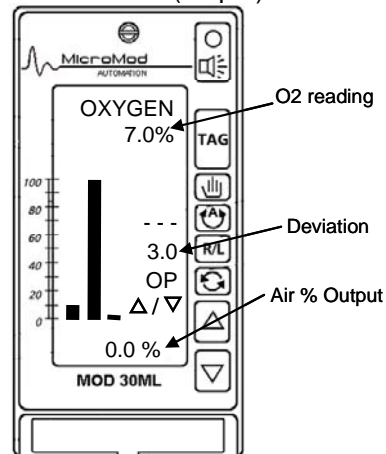

On the Combustion Test Data sheet, record the % O2 and % Air output



NOTE: the values shown on these diagrams are examples only.



Press the UP arrow key

- The rightmost digit of line 6 starts to flash
- Lines 3 and 4 now indicate FST (fast) and SLO (slow)
- The AUTO and R/L keys now function as cursor movement keys for the digits on Line 6



Use the FST and UP arrow keys to raise the output to the VFD to 70%, or the air actuator to 10%



START THE BOILER.

COMMISSIONING & STARTUP GUIDE

10.2 Fuel/Air Ratio Tables

The controller uses these tables to calibrate the jackshaft signal to the required air output.

Enter X1, Y1 for the Gas /Air Ratio:



Press the R/L key (PRV) or the Scroll key (NXT) to go to the first entry in the Gas/Air ratio table



For assistance in locating Tuning displays see Appendix A.

- Lines 1 and 2 show
 % GAS X1
 % AIR
- Line 6 shows the default value of 0.0

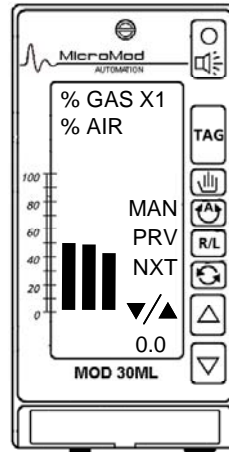

If a change is required, use the UP / DOWN arrow keys and FST / SLO keys to enter the first "X" point in the Gas/Air Ratio table

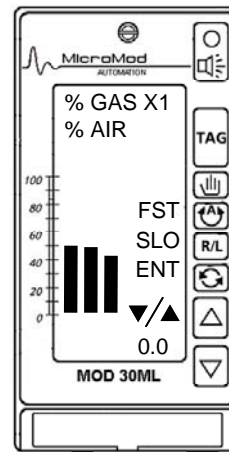

Press the ENT key

The FST, SLO and ENT indicators are replaced by MAN, PRV and NXT.

[Back to Index](#)

COMMISSIONING & STARTUP GUIDE

11 CONTROL LOOP TUNING

Following are the instructions for entering the tuning parameters for each loop in the TrimPAK controller. The installer is responsible for restarting the boiler and obtaining the correct tuning values according to the individual boiler's operational response.

11.1 Drum Pressure

If the Boiler Master has been set up for Bias Station only (receiving its signal from a Plant Master controller), skip this section and proceed to Section 11.2. If Drum Pressure or Dual Mode function was selected complete the following entries.

Drum Pressure Gain, Reset - Oil



Press the TAG key

Lines 1 and 2 indicate DRM PRES and the steam pressure in engineering units



Press and hold the Scroll key

Lines 1 and 2 display TUNE PASSWORD

Enter the tuning password **11** using the Auto/Manual (FST / SLO) and UP/DOWN keys and press the Scroll key (ENT)

The controller will display the last tuning display accessed.



Press NXT or PRV until the Steam Pressure Oil Gain display appears

- Lines 1 and 2 display DRM PRES OIL GAIN
- Line 6 shows the default value 0.6

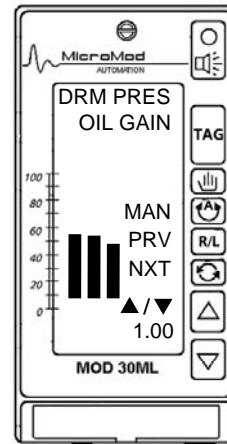

[Back to Index](#)

COMMISSIONING & STARTUP GUIDE

**Appendix C
Combustion Test Forms**

COMBUSTION TEST DATA - OIL

	% Fuel Output	% Air Output	O2 reading TrimPAK analyzer	Operating Pressure	O2 reading (portable analyzer)	Combustibles (portable analyzer)	Steam Flow (if available)
1 Low Fire							
2							
3							
4							
5							
6							
7							
8							
9 Full Load							

COMBUSTION TEST DATA - GAS

	% Fuel Output	% Air Output	O2 reading TrimPAK analyzer	Operating Pressure	O2 reading (portable analyzer)	Combustibles (portable analyzer)	Steam Flow (if available)
1 Low Fire							
2							
3							
4							
5							
6							
7							
8							
9 Full Load							

COMMISSIONING & STARTUP GUIDE

CONTROLLER LOOKUP TABLES

Oil / O2 Setpoint Table – Oil

Point	% Fuel Output	Point	% O2*
X1		Y1	
X2		Y2	
X3		Y3	
X4		Y4	
X5		Y5	
X6		Y6	
X7		Y7	
X8		Y8	
X9		Y9	

*From TrimPAK Analyzer



Note: The X1 – X9 data points for Fuel Output values should be the same for both tables, for a given fuel.

Oil / Air Ratio Table

Point	% Fuel Output	Point	% Air Output
X1		Y1	
X2		Y2	
X3		Y3	
X4		Y4	
X5		Y5	
X6		Y6	
X7		Y7	
X8		Y8	
X9		Y9	

Gas / O2 Setpoint Table

Point	% Fuel Output	Point	% O2*
X1		Y1	
X2		Y2	
X3		Y3	
X4		Y4	
X5		Y5	
X6		Y6	
X7		Y7	
X8		Y8	
X9		Y9	

*From TrimPAK Analyzer



Note: The X1 – X9 data points for Fuel Output values should be the same for both tables, for a given fuel.

Gas / Air Ratio Table

Point	% Fuel Output	Point	% Air Output
X1		Y1	
X2		Y2	
X3		Y3	
X4		Y4	
X5		Y5	
X6		Y6	
X7		Y7	
X8		Y8	
X9		Y9	